

ENG+ PARTES

Catálogo de Peças

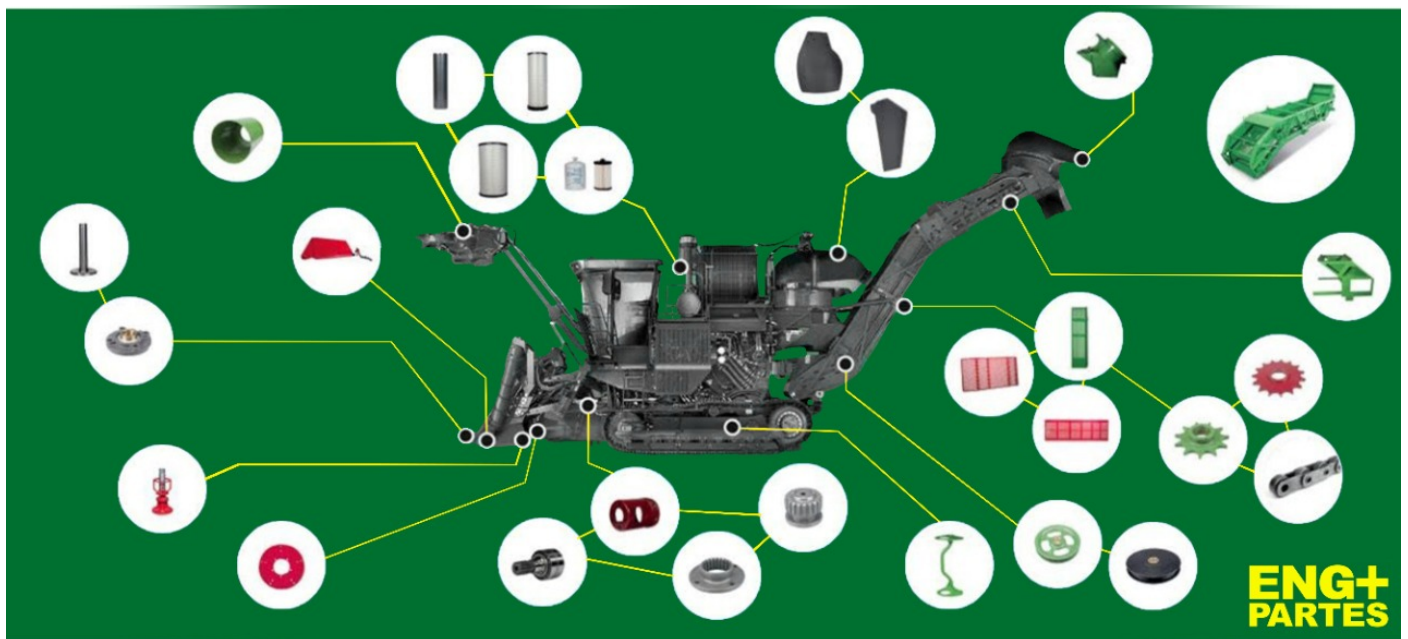

Chaparias

Filtros

Rolamentos

Engrenagens

Outros

Fabricamos para todos os modelos de colhedoras de cana-de-açúcar.

CESTO DO ELEVADOR PERFURADO



aplicação:
3510
3520
3522
CH570
CH670

Cód. Similar
CB01509559ESP / CB11472951ESP
CB11472955ESP / AXT12812ESP

PERFIL



aplicação:
3510
3520
3522
CH570
CH670

Cód. Similar
CB01460482A

ASSOALHO INF. ONDULADO

Peça única 3/16"

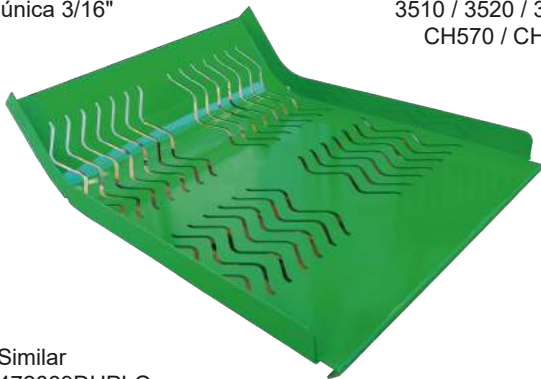

aplicação:
3510 / 3520 / 3522
CH570 / CH670

Cód. Similar
CB11472869DUPLO

ASSOALHO SUPERIOR

Reforçado 3/16"



aplicação:
3510 / 3520 / 3522
CH570 / CH670

Cód. Similar
CB11473169-3/16

DIVISOR DE LINHA

Cód. Similar
AXT11127A
AXT11133A
CB11489758A



aplicação:
3520
3522

CUBO EXTRATOR PRIMÁRIO

aplicação:
3520
CH570
CH670



Cód. Similar
AXT12352A

BANDEJA ESPECIAL (TUBO REFORÇADO)

Tubo de 2" partido maciço p/ maior reforço



aplicação:
3520
3522

Cód. Similar
AXT10100ESP

BANDEJA

aplicação:
CH570
CH670



Cód. Similar
AXT11337A

ESCADA



aplicação:
3520

Cód. Similar
CB11481036PA

PERNA CORTE BASE COM FUSIL



aplicação:
3510
3520
3522

Cód. Similar
CB11419505FUSIL
CB11478272FUSIL

BASE CAPUZ EXT. SEC.

Especial Mat. 1/8"

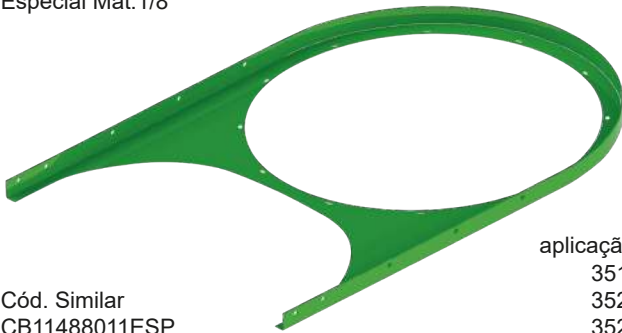

aplicação:
3510
3520
3522
CH570
CH670

Cód. Similar
CB11488011ESP
CB11488003ESP
CB11432142ESP

BRAÇO ROLO CURVO REFORÇADO

Chapa 1/2"



aplicação:
3510
3520
3522

Cód. Similar
CB11459302REF

Rolo Levantador Revestido

Cód. Similar
CB11455267ESP



aplicação:
3510
3520
3522
CH570
CH670

- Rolo Levantador Revestido com design moderno e prático, favorecendo a diminuição de impurezas minerais.

**PÁ EXTRATOR PRIMÁRIO
MAT. 1045**

aplicação:
3520
CH570
CH670



Cód. Similar
AXT12404A-1045

● Maior durabilidade

KIT DE FILTROS



Grande variedade de filtros para as diferentes marcas e modelos de colhedoras de cana-de-açúcar: JD, Case e Valtra.

SAPATA

aplicação:
3520
3522



Cód. Similar
AXT11128A

**BRAÇO SUPORTE EXTRATOR
PRIMÁRIO (QUADRADO)**

aplicação:
3510
3520
3522



Cód. Similar
AXT10345N
CB11472923N
AXT10345QUADRA
CB11472923QUADRA

ENGRENAGENS DO ELEVADOR

● Mat. 1045 com maior durabilidade ao desgaste

aplicação: 3510 / 3520 / 3522 / CH570 / CH670



Cód. Similar
CB11421303
AÇO 1045



Cód. Similar
CB11414708
AÇO 1045



Cód. Similar
0290248605-
AÇO 1045

POLIAS DO ELEVADOR LISAS

● Alternativa de sistema de polias



Cód. Similar
CB11421303LISA
AÇO 1045



Cód. Similar
CB11414708LISA
AÇO 1045

CAPUZ PRIMÁRIO



aplicação:
3510
3520
3522
CH570
CH670

Cód. Similar
NW01449114N
CB01486007N

REFIL BI-PARTIDO

Conf. original - 01 pç

aplicação:
3510 / 3520 / 3522
CH570 / CH670



Cód. Similar
CB11485364A
CB01446452A

PONTEIRA SAPATA



aplicação:
3510 / 3520 / 3522
CH570 / CH670

Cód. Similar
016523

ESCAMA CORTE BASE ESPECIAL

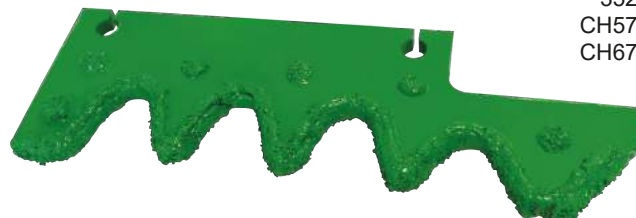

aplicação:
3510
3520
3522
CH570
CH670

Cód. Similar
066166ESP

ENGRENAGENS DA CAIXA CORTE BASE

- Mat. 8620 com tratamento térmico

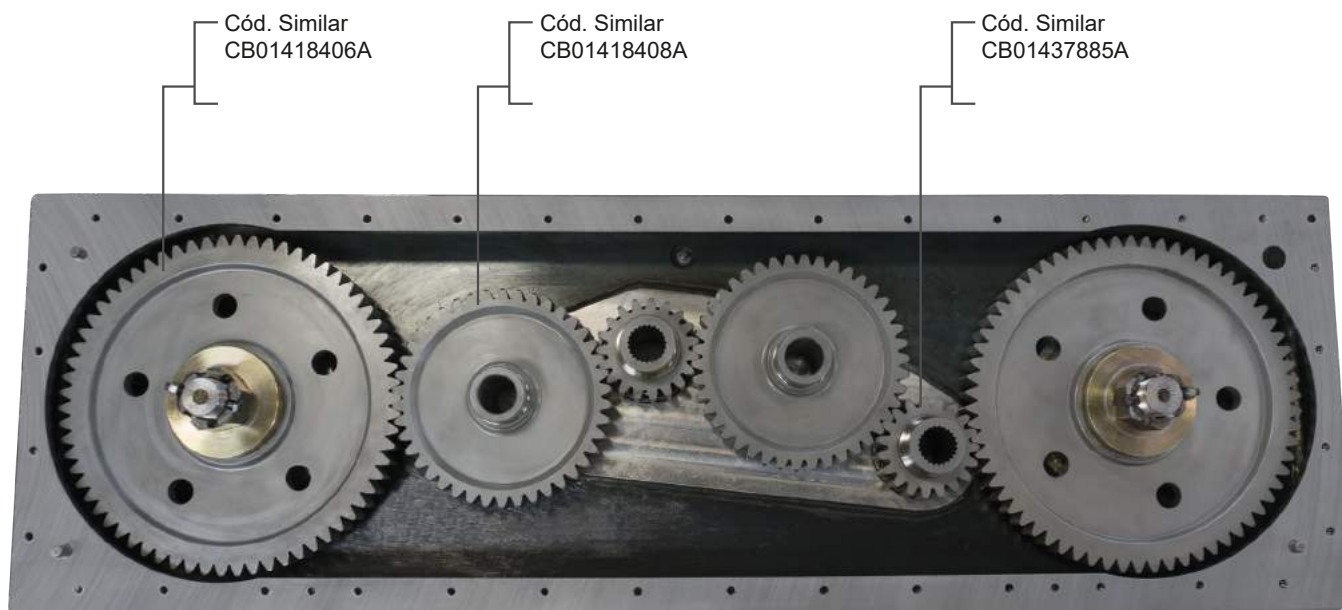

aplicação: 3510 / 3520 / 3522 / CH570 / CH670

CABO DE AÇO REVESTIDO

Cód. Similar
CB01467761ME
CB01453046ME

aplicação:
3510 / 3520 / 3522
CH570 / CH670



- Cabo de aço 3/4" com revestimento nylon 12 e presilha de alumínio.
- Melhoria que garante maior vida útil.



ROLDANA MONTADA

Cód. Similar: CB11473161N

aplicação:
3510
3520
3522
CH570
CH670



RODA GUIA

Nylontec+ Bronze

Cód. Similar
CB01437522PA



RODA GUIA AÇO

Polia em aço c/ rolamento

Cód. Similar
CB01437522ACO

VIDROS

- Para os novos modelos CH

PARABRISA

Cód. Similar: KXE10247A

aplicação:
CH570
CH670

PORTA LD

Cód. Similar: L212249A

PORTA LE

Cód. Similar: L212856A



PINO

aplicação:
7000 / 7700 / 8000
8800 / 8800 Multi-Row



Cód. Similar
87245599A

PISTÃO FREIO

aplicação:
7000 / 7700 / 8000
8800 / 8800 Multi-Row



Cód. Similar
86308778A

ALOJAMENTO

aplicação:
7000 / 7700
8000 / 8800
8800 Multi-Row



Cód. Similar
87598567A

TALISCA ELEVADOR 3 VINCOS

● Estrutura mais reforçada

aplicação:
7000
7700
8000
8800
8800 Multi-Row

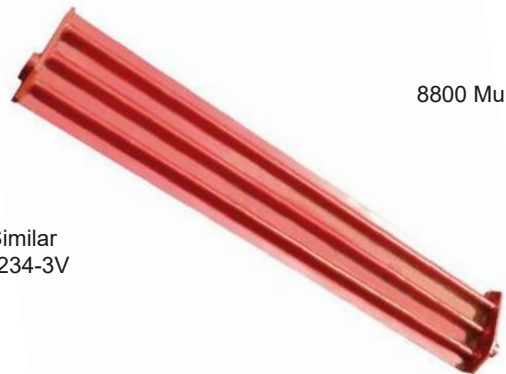

Cód. Similar
87236234-3V

PERNA CORTE BASE COM FUSIL

Cód. Similar
446620A1



aplicação:
7000 / 7700
8000 / 8800
8800 Multi-Row

BRAÇO

aplicação:
7000 / 7700
8000 / 8800
8800 Multi-Row



Cód. Similar
87240288
86697001
87213933

SUPORTE

aplicação:
7000 / 7700
8000 / 8800
8800 Multi-Row



Cód. Similar
87368563A

ROLO

aplicação:
7700
8800

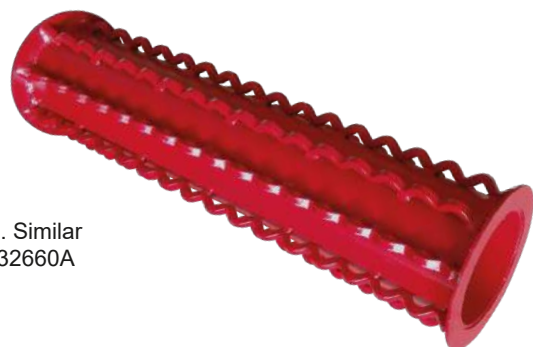

Cód. Similar
87232660A

CUBO CORTE LATERAL

Cód. Similar
87217492A



aplicação:
7000 / 7700 / 8000
8800 / 8800 Multi-Row

SUPORTE MANIVELA

aplicação:
8000 / 8800
8800 Multi-Row



Cód. Similar
84300377A
47912052A

PORTA DE AÇO PERFURADA

Cód. Similar
8737773A



aplicação:
8000 / 8800
8800 Multi-Row

TUBO MOLA

aplicação:
7000
7700



Cód. Similar
87239934A

SUPORTE

Cód. Similar
87251842

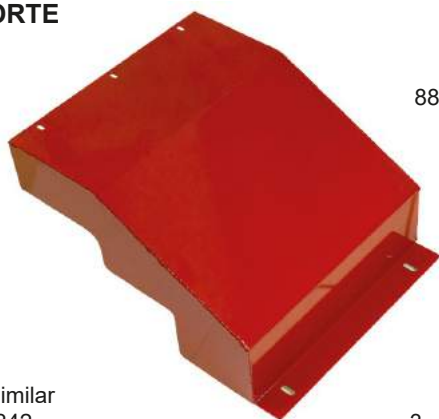

aplicação:
7000 / 7700
8000 / 8800
8800 Multi-Row

3

DEFLETOR

aplicação:
7000 / 7700 / 8000 / 8800
8800 Multi-Row

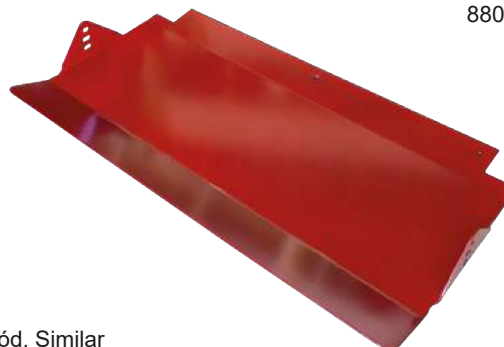

Cód. Similar
87251098PA

EIXO

Cód. Similar
87410456

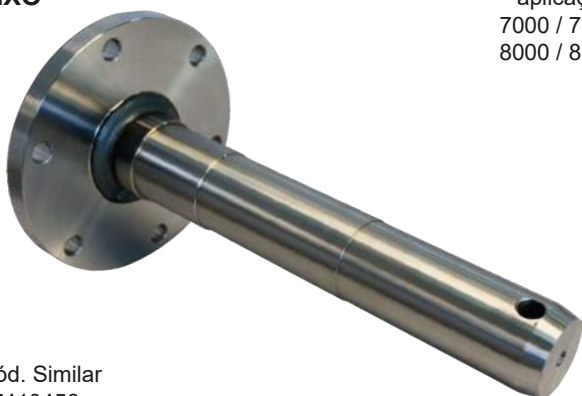

aplicação:
7000 / 7700
8000 / 8800

GUIA LD

aplicação:
8000 / 8800
8800 Multi-Row



Cód. Similar
84155849A

DISCO CORTE BASE



aplicação:
7000
7700
8000
8800

Cód. Similar
87244040 / 87239448

PLACA REGULADORA



aplicação:
7000 / 7700
8000 / 8800
8800 Multi-Row

Cód. Similar
87214036

ASSOALHO LISO PARA PLANTIO

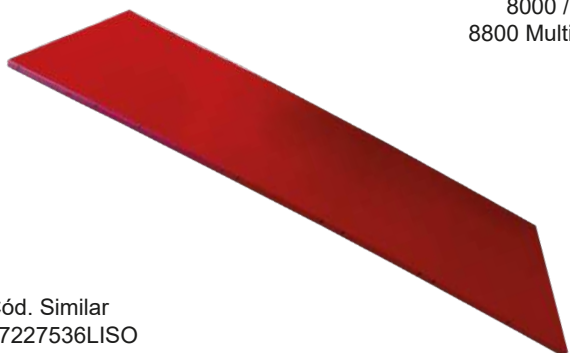

aplicação:
7000 / 7700
8000 / 8800
8800 Multi-Row

Cód. Similar
87227536LISO
87250041LISO

ANEL GIRO



aplicação:
7000
7700

Cód. Similar
87250473PA
87246780PA

SUPORTE



aplicação:
8000
8800

Cód. Similar
87435258

BRAÇO



aplicação:
7000
7700

Cód. Similar
87254776A

CHAPA



aplicação:
7000 / 7700
8000 / 8800
8800 Multi-Row

Cód. Similar
87255691
86972500

CUBO EXTRATOR PRIMÁRIO



aplicação:
8000 / 8800
8800 Multi-Row

Cód. Similar
87248284

ASSOALHO PERFURADO (CONF. ORIGINAL)

Cód. Similar
87236397A

aplicação:
7000 / 7700
8000 / 8800

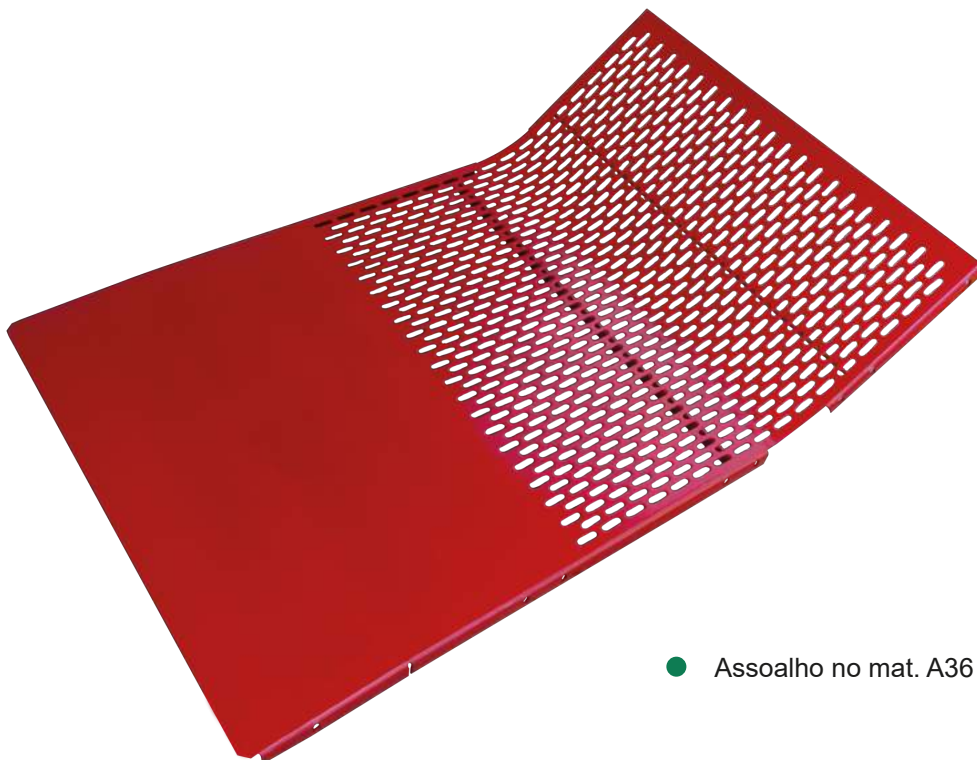

● Assoalho no mat. A36

ANEL PROTEÇÃO ESP. 1/4"

Cód. Similar
87241695ESP

aplicação:
7000 / 7700
8000 / 8800

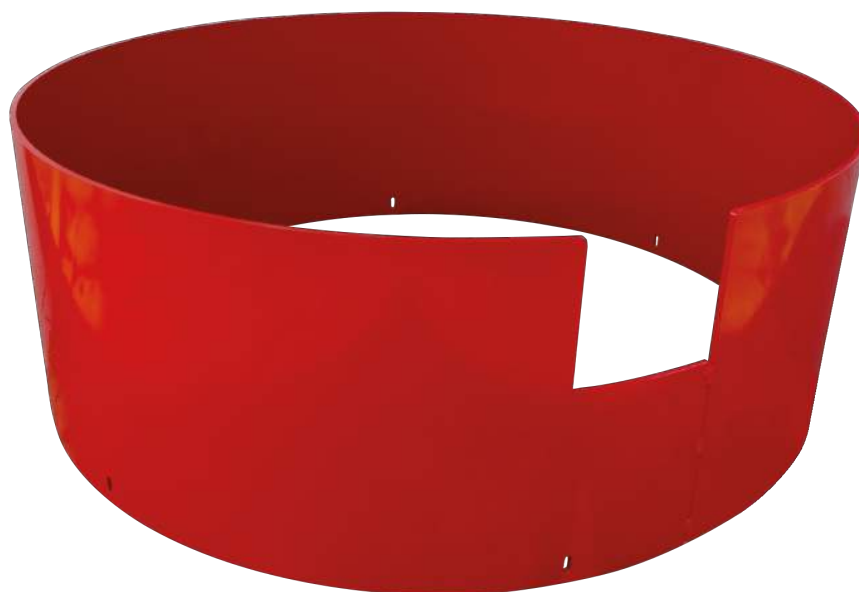

● Anel desgaste no mat. A36
ESP. 1/4"

ENGRENAGENS

aplicação:
7000 / 7700
8000 / 8800
8800 Multi-Row

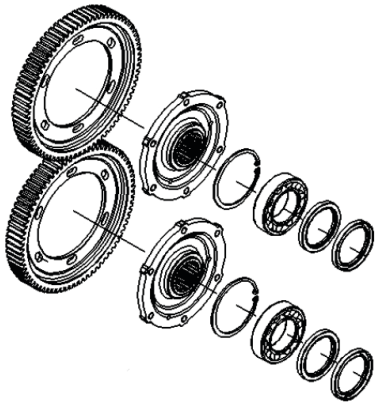

Cód. Similar
87239615A

SAE 8620



Cód. Similar
87239608A

SAE 8620



- FABRICADO NO MAT. SAE 8620 COM TRATAMENTO TÉRMICO.

ROLO ESPECIAL

Cód. Similar
87232660ESP



aplicação:
7000 / 7700
8000 / 8800
8800 Multi-Row

- Rolo em sistema espiral forçando uma uniformidade da cana na entrada do rolo picador, assim o facão picador é explorado por igual.



ENGRENAGENS DO ELEVADOR

aplicação:
7000 / 7700 / 8000
8800 / 8800 Multi-Row

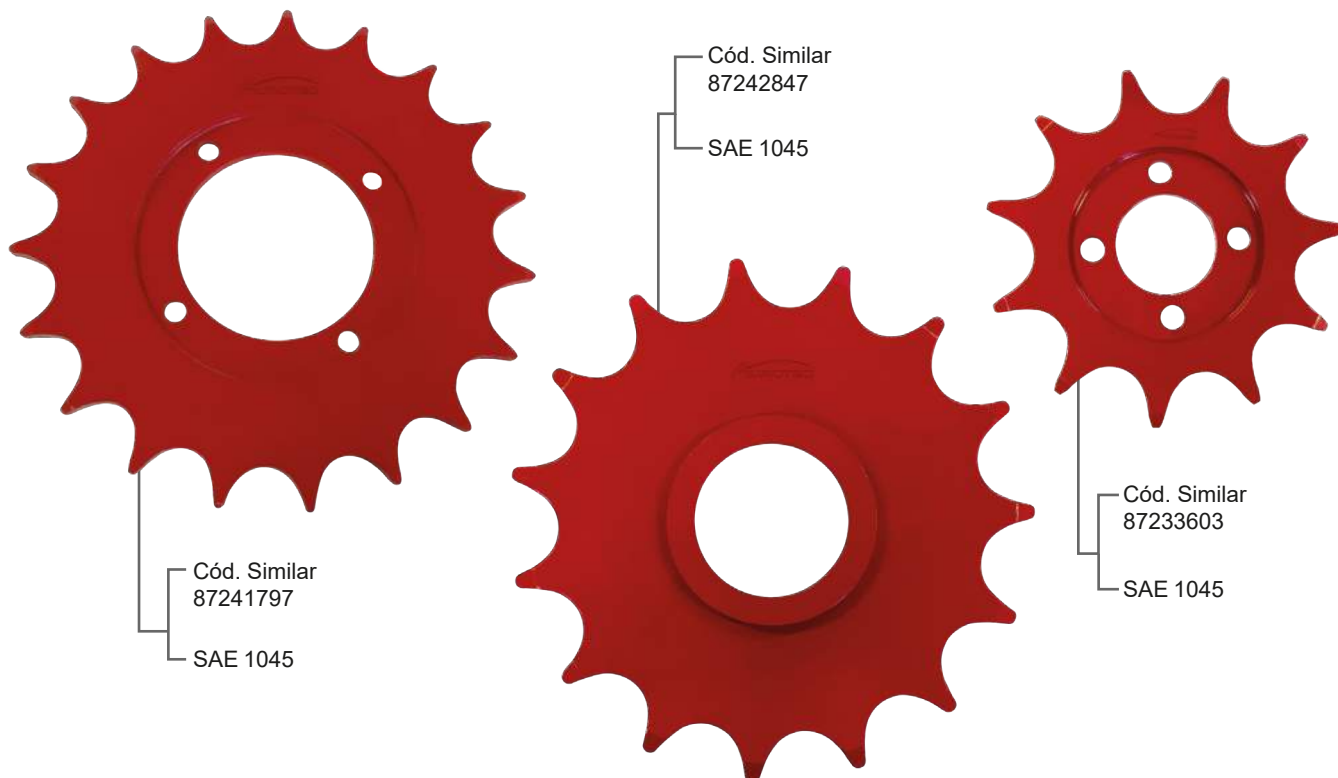

ENGRENAGENS DA CAIXA CORTE BASE

- Fabricado no Mat. 8620 com tratamento térmico

aplicação:
7000 / 7700 / 8000
8800 / 8800 Multi-Row



Componentes e melhorias

linha amarela

Para atender a demanda por soluções e superar os desafios que as máquinas enfrentam durante a safra, concentramos nossos esforços na fabricação de peças resistentes porque a colheita não pode parar assim como nossa busca por inovação e qualidade.



Seção de componentes e acessórios Aurotec aplicados nas máquinas Valtra.

TALISCA

Cód. Similar
091906.000GA
091906.000CA

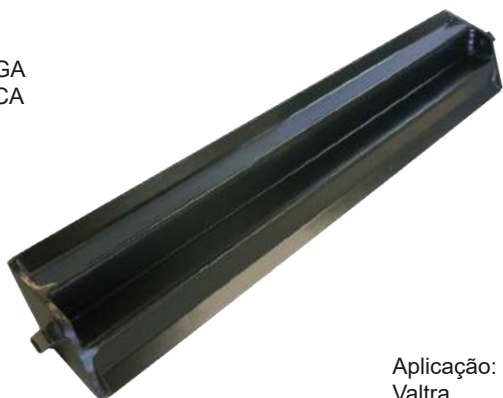

Aplicação:
Valtra

TALISCA ESPECIAL

Aplicação:
Valtra



Cód. Similar
091906.000CAESP

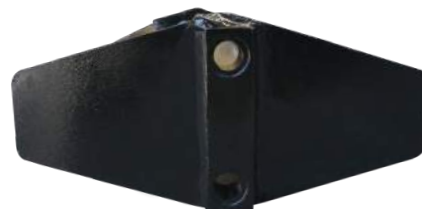

- Talisca fabricada com vinco arredondado que garante maior reforço na estrutura da mesma.

PÁ EXTRATOR PRIMÁRIO

Mat. A36; jogo com 03 pás

Cód. Similar
1903.363.5A



Aplicação:
Valtra

DISCO CORTE BASE 6F VALTRA

- Revestido com eletrodo duro

Cód. Similar
250501.000AA



- Disco revestido com eletrodo duro que garante uma dureza de 62HRC

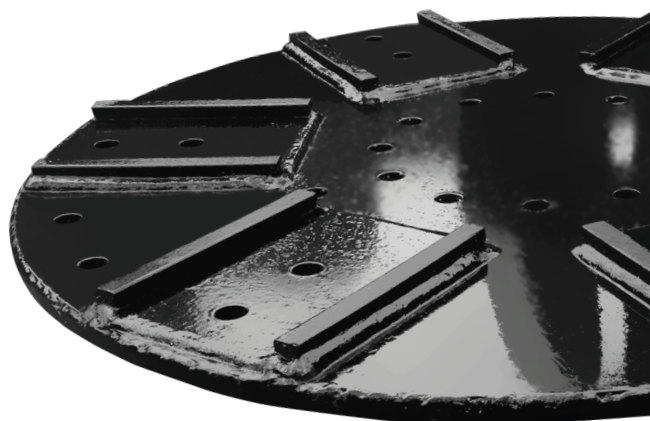

Aplicação:
Valtra

ROLAMENTO VEDADO (BORRACHA)

Cód. Similar
CB11469977A
CB01478069A

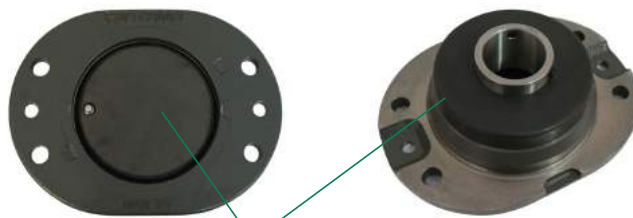

● Mancal com vedação em borracha.

aplicação:
3510
3520
3522
CH570
CH670

ROLAMENTO VEDADO (AÇO)

Cód. Similar
CB11469977ESP
CB01478069ESP

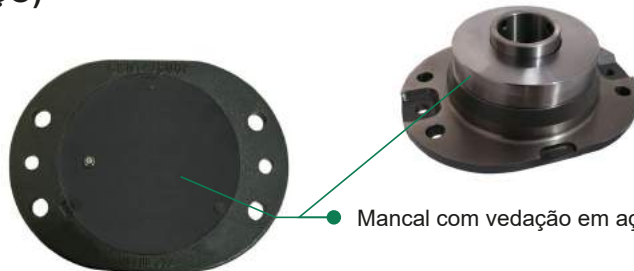

● Mancal com vedação em aço.

KIT MANCAL

Cód. Similar
016000A

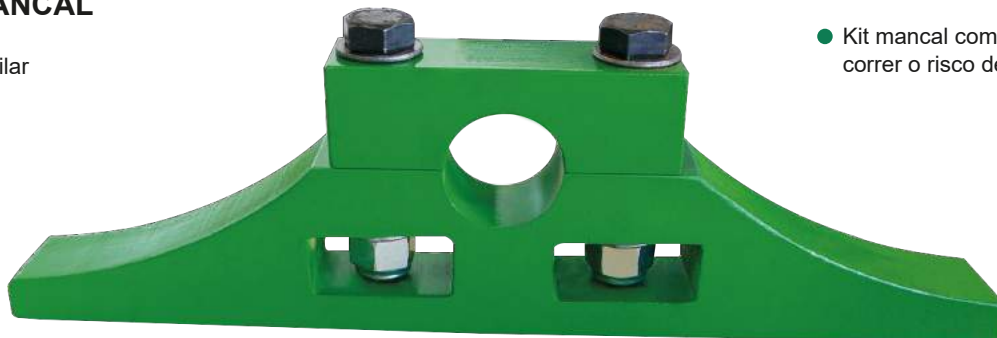

● Kit mancal com parafuso passante sem correr o risco de espanar a rosca.

aplicação:
3510
3520
3522
CH570
CH670

CORRENTE DO ELEVADOR



Cód. Similar CB01433201
0211378757

REXNORD

Produto comercializado
nas diferentes medidas:
12,50 m
13,00 m
11,08 m

aplicação:
3510 / 3520 / 3522
CH570 / CH670
7000 / 7700
8000 / 8800
8800 Multi-Row

EIXO ROLAMENTO FORJADO

Cód. Similar
0331382906A
CB01409711A



aplicação:
3510
3520
3522
CH570
CH670